

OPERATION MANUAL

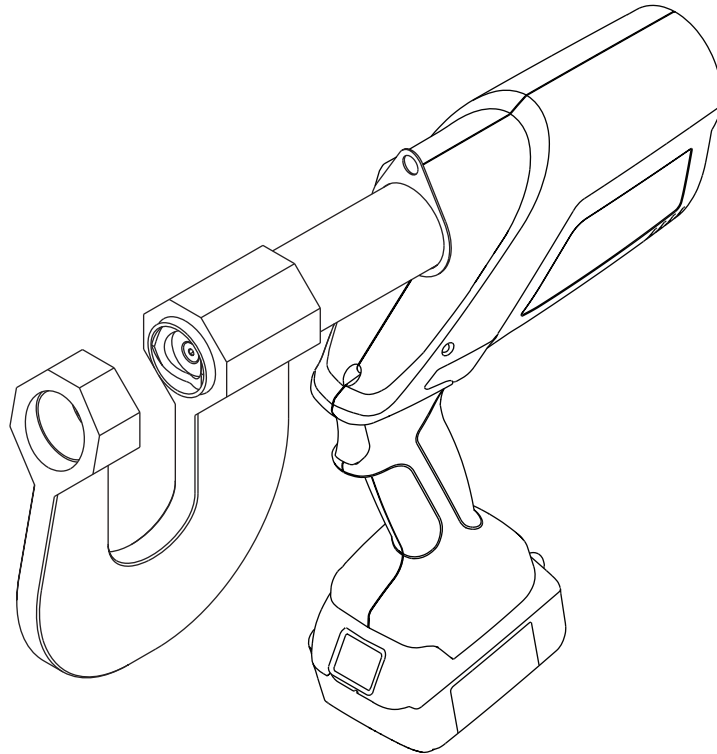

Serial Number



GATOR[®] ESP710L **Battery-powered** **Stud Punch**



Read and understand all of the instructions and safety information in this manual before operating or servicing this tool.

Register this product at www.greenlee.com

Table of Contents

Description	2
Safety	2
Purpose of this Manual	2
Important Safety Information	3-4
Identification	5
Specifications	5
Operation	6
Maintenance	7
Troubleshooting	8

Description

The ESP710L Battery-powered Stud Punch is a hand-held, self-contained tool intended to punch a 1.34" (34 mm) hole in metal studs up to 16 gauge thick.

This tool is protected by U.S. Patent No. 6,206,663, 6,276,186, and 6,401,515.

Safety

Safety is essential in the use and maintenance of Greenlee tools and equipment. This manual and any markings on the tool provide information for avoiding hazards and unsafe practices related to the use of this tool. Observe all of the safety information provided.

Purpose of this Manual

This manual is intended to familiarize all personnel with the safe operation and maintenance procedures for the following Greenlee tool:

ESP710L Battery-powered Stud Punch

Keep this manual available to all personnel.

Replacement manuals are available upon request at no charge at www.greenlee.com.



Do not discard this product or throw away!

For recycling information, go to www.greenlee.com.

All specifications are nominal and may change as design improvements occur. Greenlee Tools, Inc. shall not be liable for damages resulting from misapplication or misuse of its products. GATOR is a registered trademark of Greenlee Tools, Inc.

KEEP THIS MANUAL

IMPORTANT SAFETY INFORMATION



SAFETY ALERT SYMBOL

This symbol is used to call your attention to hazards or unsafe practices which could result in an injury or property damage. The signal word, defined below, indicates the severity of the hazard. The message after the signal word provides information for preventing or avoiding the hazard.

⚠️ DANGER

Immediate hazards which, if not avoided, **WILL** result in severe injury or death.

⚠️ WARNING

Hazards which, if not avoided, **COULD** result in severe injury or death.

⚠️ CAUTION

Hazards or unsafe practices which, if not avoided, **MAY** result in injury or property damage.

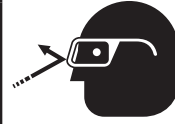

⚠️ WARNING

Wear eye protection when operating or servicing this tool.

Failure to wear eye protection could result in serious eye injury from flying debris or hydraulic oil.



⚠️ WARNING

Skin injection hazard:

Do not use hands to check for oil leaks. Oil under pressure easily punctures skin. If injured, seek medical attention immediately to remove oil.

Failure to observe this warning could result in serious injury, gangrene, or death.



⚠️ WARNING

Do not use solvents or flammable liquids to clean the tool body. Solvents or flammable liquids could ignite and cause serious injury or property damage.



⚠️ WARNING

Read and understand all of the instructions and safety information in this manual before operating or servicing this tool.

Failure to observe this warning could result in severe injury or death.



⚠️ WARNING

Electric shock hazard:

This tool is not insulated. When using this unit on or near energized electrical lines, use proper personal protective equipment.

Failure to observe this warning could result in severe injury or death.



⚠️ WARNING

Pinch points:

- Remove battery before changing dies, adapters, or jaws.
- Keep hands away from the tool head when punching.

Failure to observe these warnings could result in severe injury or death.

⚠️ WARNING

Do not dispose of batteries in a fire. They will vent fumes and may explode.

Failure to observe this warning could result in severe injury from harmful fumes or burns from flying debris.

IMPORTANT SAFETY INFORMATION

⚠ WARNING

- Inspect tool and dies before use. Replace any worn or damaged parts. A damaged or improperly assembled tool can break and strike nearby personnel.
- Carrying strap is for carrying only, not to be used to hang or suspend tool.

Failure to observe these warnings could result in severe injury or death.

⚠ CAUTION

- Do not store the battery at more than 122 °F (50 °C) or less than -4 °F (-20 °C). Damage to the battery can result.
- Do not use another manufacturer's charger. Other manufacturers' chargers may overcharge and damage the battery.
- Do not attempt to open the battery. It contains no user-serviceable parts.

Failure to observe these precautions may result in injury or property damage.

⚠ CAUTION

- Do not operate tool without dies. Damage to the ram or C-head may result.
- Do not use this tool for continuous use. After 30 to 40 cycles, allow the tool to cool for 15 minutes.
- Do not secure this tool in a vise. This tool is designed for hand-held operation.
- This tool may be used in damp or wet environments; however, air-drying is recommended before use if the tool becomes soaked. Damage may result when the tool is operated prior to thorough drying when electrical components are soaked.
- Use this tool for the manufacturer's intended purpose only.

Failure to observe these precautions may result in injury or property damage.

⚠ CAUTION

Do not perform any service or maintenance other than as described in this manual. Injury or damage to the tool may result.

Failure to observe this precaution may result in injury and property damage.

Note: Keep all decals clean and legible, and replace when necessary.

⚠ CAUTION

Do not allow anything to contact the battery terminals.

- Do not immerse the batteries in liquid. Liquid may create a short circuit and damage the battery. If batteries are immersed, contact your service center for proper handling.
- Do not place the battery into a pocket, tool pouch, or tool box with conductive objects. Conductive objects may create a short circuit and damage the battery.
- Do not place a battery on moist ground or grass. Moisture may create a short circuit and damage the battery.

Failure to observe these precautions may result in injury or property damage.

Identification

1. C-Head
2. Punch
3. Lanyard Ring
4. Housing
5. Retract Button
6. LED Indicator (red)
7. LED Work Light (white)
8. Battery
9. Trigger

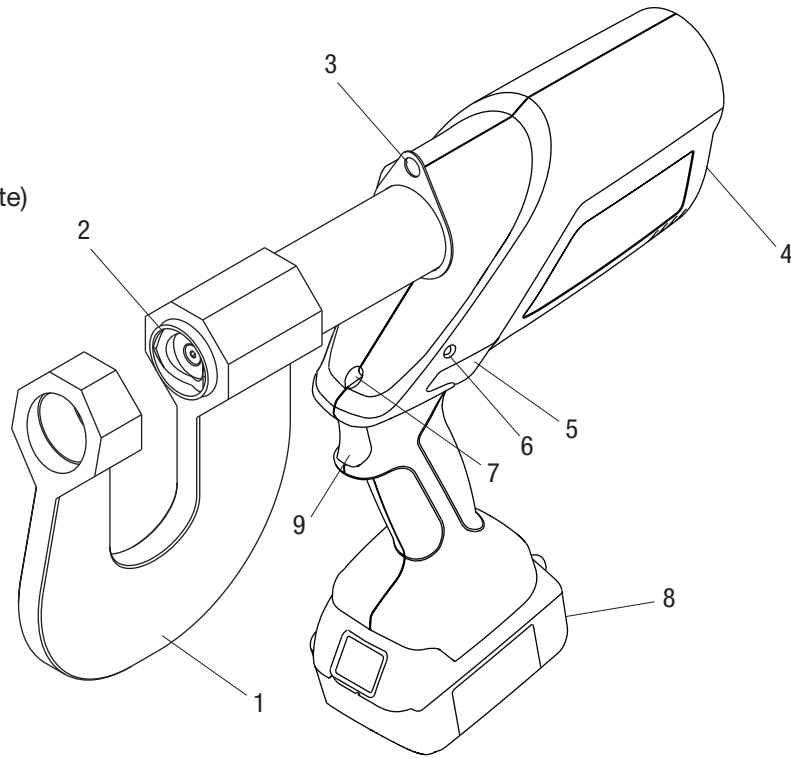

Specifications

Punching Tool

Length.....	15" (381 mm)
Width	2.87" (72.9 mm)
Height	12.5" (317.5 mm)
Weight.....	8.8 lb (4 kg)
Hydraulic Oil	52057878 biodegradable hydraulic fluid
Recommended Operating Temperature Range	5 °F to 122 °F (-15 °C to 50 °C)
Battery Charger.....	Read the instructions supplied with the battery charger

52047087	120 VAC corded adapter	52049202	230 VAC, 18 V charger
52047088	230 VAC corded adapter	52049204	12 VDC, 18 V charger
52049189	18 V, 3 Ah lithium-ion battery	52054992	Li (18 V) to NiCd, NiMH (12 V) charger adapter
52049201	120 VAC, 18 V charger	50122746	Carrying strap

Operation

⚠ WARNING

- Inspect tool and dies before use. Replace any worn or damaged parts. A damaged or improperly assembled tool can break and strike nearby personnel.
- Carrying strap is for carrying only, not to be used to hang or suspend tool.

Failure to observe these warnings could result in severe injury or death.

⚠ WARNING



Electric shock hazard:

This tool is not insulated. When using this unit on or near energized electrical lines, use proper personal protective equipment.

Failure to observe this warning could result in severe injury or death.

⚠ WARNING

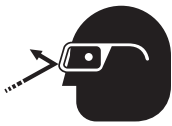

Wear eye protection when operating or servicing this tool.

Failure to wear eye protection could result in serious eye injury from flying debris or hydraulic oil.

⚠ WARNING



Pinch points:

- Remove battery before changing dies, adapters, or jaws.
- Keep hands away from the tool head when punching.

Failure to observe these warnings could result in severe injury or death.

⚠ CAUTION

- Do not operate tool without dies. Damage to the ram or C-head may result.
- Do not use this tool for continuous use. After 30 to 40 cycles, allow the tool to cool for 15 minutes.
- Do not secure this tool in a vise. This tool is designed for hand-held operation.
- This tool may be used in damp or wet environments; however, air-drying is recommended before use if the tool becomes soaked. Damage may result when the tool is operated prior to thorough drying when electrical components are soaked.
- Use this tool for the manufacturer's intended purpose only.

Failure to observe these precautions may result in injury or property damage.

Charging the Battery

Read the instructions supplied with the battery charger.

LED Work Light (white)

This LED automatically turns on when the trigger is pulled. It remains on for 10 seconds after the trigger is released.

LED Indicator (red)

This tool is equipped with a special circuit board incorporating several important features to inform the user about the current status of the unit. The LED signals in the following cases:

What happens	Signal	What it means
Flashing light for 2 seconds	● ●	Battery is inserted in tool
Constant light for 20 seconds at end of cycle	▬	Battery charge is below 17 V at beginning of cycle
Tool will not start, and constant light for 20 seconds when trigger is released	▬	Battery charge is below 16 V at beginning of cycle
Tool will stop, and constant light for 20 seconds after trigger is released	▬	Battery voltage drops below 13 V during cycle
Tool will stop, and flashing light for 20 seconds when trigger is released	● ● ● ●	Motor current exceeds 20 A during cycle Circuit has become too hot

Maintenance

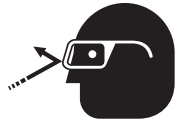
	⚠ WARNING
	<p>Wear eye protection when operating or servicing this tool.</p> <p>Failure to wear eye protection could result in serious eye injury from flying debris or hydraulic oil.</p>

	⚠ WARNING
	<p>Skin injection hazard:</p> <p>Do not use hands to check for oil leaks. Oil under pressure easily punctures skin. If injured, seek medical attention immediately to remove oil.</p> <p>Failure to observe this warning could result in serious injury, gangrene, or death.</p>

	⚠ WARNING
	<p>Do not use solvents or flammable liquids to clean the tool body. Solvents or flammable liquids could ignite and cause serious injury or property damage.</p>

	⚠ WARNING
	<p>Pinch points:</p> <ul style="list-style-type: none"> • Remove battery before changing dies, adapters, or jaws. • Keep hands away from the tool head when punching. <p>Failure to observe these warnings could result in severe injury or death.</p>

IMPORTANT
Relief valve adjustments must be done by an authorized service center.

Daily

Before use:

1. Inspect the tool for wear or damage, such as cracks, gouges, or chips.
2. Inspect the tool for damage or leaks.
3. Inspect the rotation of the head assembly. Fully retract the ram. The head should rotate no more than 360°. If damage is detected, send the tool to a Greenlee Authorized Service Center for inspection.
4. Inspect punch to piston assembly for a tight fit.

After use:

1. Use a damp cloth and mild detergent to clean the housing. Allow the housing to dry.
2. Fully retract the ram. Place the tool in the carrying case and store in a cool, dry place.
3. If necessary, recharge the batteries. Refer to the instructions supplied with the battery charger.

Monthly

1. Thoroughly clean all surfaces.
2. Check the oil level.

Annually or After 10,000 Punches

1. Replace the hydraulic oil.
2. Send the tool to a Greenlee Authorized Service Center for inspection.

Checking the Oil Level

1. Remove the screws holding the housing cover together.
2. Point the tool head downward and remove the oil reservoir plug. Fill reservoir if necessary.
3. Replace the oil plug and housing cover.

Note: For Warranty Service or Repair, contact Greenlee customer service at 800-435-0786.

Troubleshooting

Before You Begin

1. Make sure that the battery is charged. Recheck the battery after several minutes to make sure the battery is holding its charge.
2. Use a **nonflammable** contact cleaner or pencil eraser to clean the electrical contacts on the battery and tool.
3. Reinstall the battery and check the tool again.

Problem	Possible Cause	Probable Remedy
Tool is inoperative.	Dirt, contaminants, etc., in ram area of tool.	Clean tool.
	Tool battery contacts damaged.	Reform contacts.
	Tool components worn or damaged.	Return tool to a Greenlee Authorized Service Center.
Motor is inoperative.	Low or uncharged battery.	Try known charged battery. Inoperative battery may be discharged or may have reached life expectancy.
	Broken switch components.	Return tool to a Greenlee Authorized Service Center.
Motor runs but tool will not complete a cycle.	Oil level low.	Return tool to a Greenlee Authorized Service Center.
	Air in hydraulic system.	Pull trigger and hold retract button simultaneously. Run for approximately 10 seconds, and then attempt to punch. If unsuccessful, return tool to a Greenlee Authorized Service Center.
	Cold oil.	Pull trigger and hold retract button simultaneously to warm oil. Store tool in warm area.
Dies stop during operation.	Oil level low.	Return tool to a Greenlee Authorized Service Center.
	Air in hydraulic system.	Pull trigger and hold retract button simultaneously. Hold for approximately 10 seconds.
LED glows for 20 seconds.	Battery charge low.	Charge or replace battery.
Tool loses oil.	Damaged internal seal.	Return tool to a Greenlee Authorized Service Center.

Note: For Warranty Service or Repair, contact Greenlee customer service at 800-435-0786.