

OPERATION MANUAL

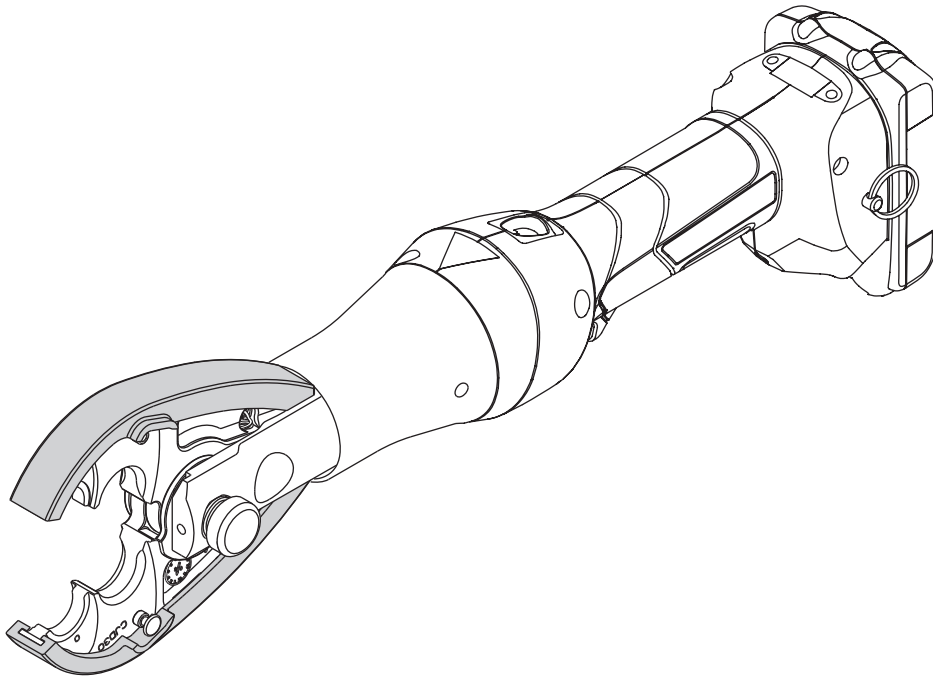

GREENLEE®
A Textron Company

Serial Number



EK425LX **GATOR® Battery-powered** **Crimping Tool**



Read and understand all of the instructions and safety information in this manual before operating or servicing this tool.

Register this product at www.greenlee.com

Table of Contents

Description	2
Safety	2
Purpose of this Manual	2
Important Safety Information	3-4
Identification	5
Specifications	5
Operation	6-7
Die and Connector Selection	8
LCD Screen	9
Maintenance	10
Troubleshooting	11

Description

The EK425LX Battery-powered Crimping Tool is a hand-held, self-contained crimping tool with removable crimping jaws.

This tool has a Bluetooth® connectivity and an LCD screen.

The tool is protected by U.S. Patent No. 6,276,186, 6,401,515, 6,718,870, 7,086,979, 7,216,523, and 7,254,982.

Model X-EK425LX – FCC ID: 2AGL2X IC ID: 20646X

This device complies with Part 15 of the FCC Rules and with Industry Canada licence-exempt RSS standard(s). Operation is subject to the following two conditions: (1) this device may not cause harmful interference, and (2) this device must accept any interference received, including interference that may cause undesired operation

Note: Change or modifications made to this equipment not expressly approved by Greenlee may void the FCC authorization to operate this equipment.

Safety

Safety is essential in the use and maintenance of Greenlee tools and equipment. This manual and any markings on the tool provide information for avoiding hazards and unsafe practices related to the use of this tool. Observe all of the safety information provided.

Note: For body worn operation, this device has been tested and meets the FCC RF exposure guidelines for an uncontrolled environment. The maximum reported SAR value is 0.08 mW/g

Purpose of this Manual

This manual is intended to familiarize all personnel with the safe operation and maintenance procedures for the following Greenlee tool:

- EK425LX Battery-powered Crimping Tool

Keep this manual available to all personnel.

Replacement manuals are available upon request at no charge at www.greenlee.com.



Do not discard this product or throw away!

For recycling information, go to www.greenlee.com.

All specifications are nominal and may change as design improvements occur. Greenlee Textron Inc. shall not be liable for damages resulting from misapplication or misuse of its products.

GATOR is a registered trademark of Textron Innovations Inc.

Bluetooth is a registered trademark of Bluetooth SIG, Inc.

Blackburn is a registered trademark of Thomas & Betts.

KEEP THIS MANUAL

IMPORTANT SAFETY INFORMATION



SAFETY ALERT SYMBOL

This symbol is used to call your attention to hazards or unsafe practices which could result in an injury or property damage. The signal word, defined below, indicates the severity of the hazard. The message after the signal word provides information for preventing or avoiding the hazard.

⚠ **DANGER**

Immediate hazards which, if not avoided, **WILL** result in severe injury or death.

⚠ **WARNING**

Hazards which, if not avoided, **COULD** result in severe injury or death.

⚠ **CAUTION**

Hazards or unsafe practices which, if not avoided, **MAY** result in injury or property damage.

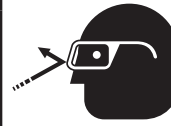

⚠ **WARNING**

Wear eye protection when operating or servicing this tool.

Failure to wear eye protection could result in serious eye injury from flying debris or hydraulic oil.



⚠ **WARNING**

Skin injection hazard:

Do not use hands to check for oil leaks. Oil under pressure easily punctures skin. If injured, seek medical attention immediately to remove oil.

Failure to observe this warning could result in serious injury, gangrene, or death.



⚠ **WARNING**

Do not use solvents or flammable liquids to clean the tool body. Solvents or flammable liquids could ignite and cause serious injury or property damage.



⚠ **WARNING**

Read and understand all of the instructions and safety information in this manual before operating or servicing this tool.

Failure to observe this warning could result in severe injury or death.



⚠ **WARNING**

Electric shock hazard:

This tool is not insulated. When using this unit on or near energized electrical lines, use proper personal protective equipment.

Failure to observe this warning could result in severe injury or death.

⚠ **WARNING**

An incomplete crimp can cause a fire.

- Use proper die, connector, and cable combinations. Improper combinations can result in an incomplete crimp.
- The relief valve sounds and the ram automatically retracts to indicate a completed crimp. If you do not hear the sound of the relieve valve or the ram does not automatically retract, the crimp is not complete.

Failure to observe these warnings could result in severe injury or death.



⚠ **WARNING**

Pinch points:

- Remove battery before changing dies, adapters, or jaws.
- Keep hands away from the crimping tool head when crimping.

Failure to observe these warnings could result in severe injury or death.

IMPORTANT SAFETY INFORMATION

⚠ WARNING

Do not dispose of batteries in a fire. They will vent fumes and may explode.

Failure to observe this warning could result in severe injury from harmful fumes or burns from flying debris.

⚠ WARNING

Remove the battery before transporting the T version of this tool by air.

Failure to observe this warning could result in severe injury or death.

⚠ WARNING

- Inspect tool and dies before use. Replace any worn or damaged parts. A damaged or improperly assembled tool can break and strike nearby personnel.
- Carrying strap is for carrying only, not to be used to hang or suspend tool.

Failure to observe these warnings could result in severe injury or death.

⚠ CAUTION

- Do not use this tool for continuous use. After 30 to 40 cycles, allow the tool to cool for 15 minutes.
- Do not secure this tool in a vise. This tool is designed for hand-held operation.
- This tool may be used in damp or wet environments; however, air-drying is recommended before use if the tool becomes soaked. Damage may result when the tool is operated prior to thorough drying when electrical components are soaked.
- Use this tool for the manufacturer's intended purpose only.

Failure to observe these precautions may result in injury or property damage.

⚠ CAUTION

Do not allow anything to contact the battery terminals.

- Do not immerse the batteries in liquid. Liquid may create a short circuit and damage the battery. If batteries are immersed, contact your service center for proper handling.
- Do not place the battery into a pocket, tool pouch, or tool box with conductive objects. Conductive objects may create a short circuit and damage the battery.
- Do not place a battery on moist ground or grass. Moisture may create a short circuit and damage the battery.

Failure to observe these precautions may result in injury or property damage.

⚠ CAUTION

- Do not store the battery at more than 122 °F (50 °C) or less than -4 °F (-20 °C). Damage to the battery can result.
- Do not use another manufacturer's charger. Other manufacturers' chargers may overcharge and damage the battery.
- Do not attempt to open the battery. It contains no user-serviceable parts.

Failure to observe these precautions may result in injury or property damage.

⚠ CAUTION

Do not perform any service or maintenance other than as described in this manual. Injury or damage to the tool may result.

Failure to observe this precaution may result in injury and property damage.

Note: Keep all decals clean and legible, and replace when necessary.

Identification

- 1. Lock Pin
- 2. Crimping Jaws
- 3. Jaw Covers
- 4. Retract Button
- 5. LCD Screen
- 6. Battery Cartridge
- 7. LED Indicator (red)
- 8. Lanyard Ring
- 9. LED Work Light (white)
- 10. Trigger

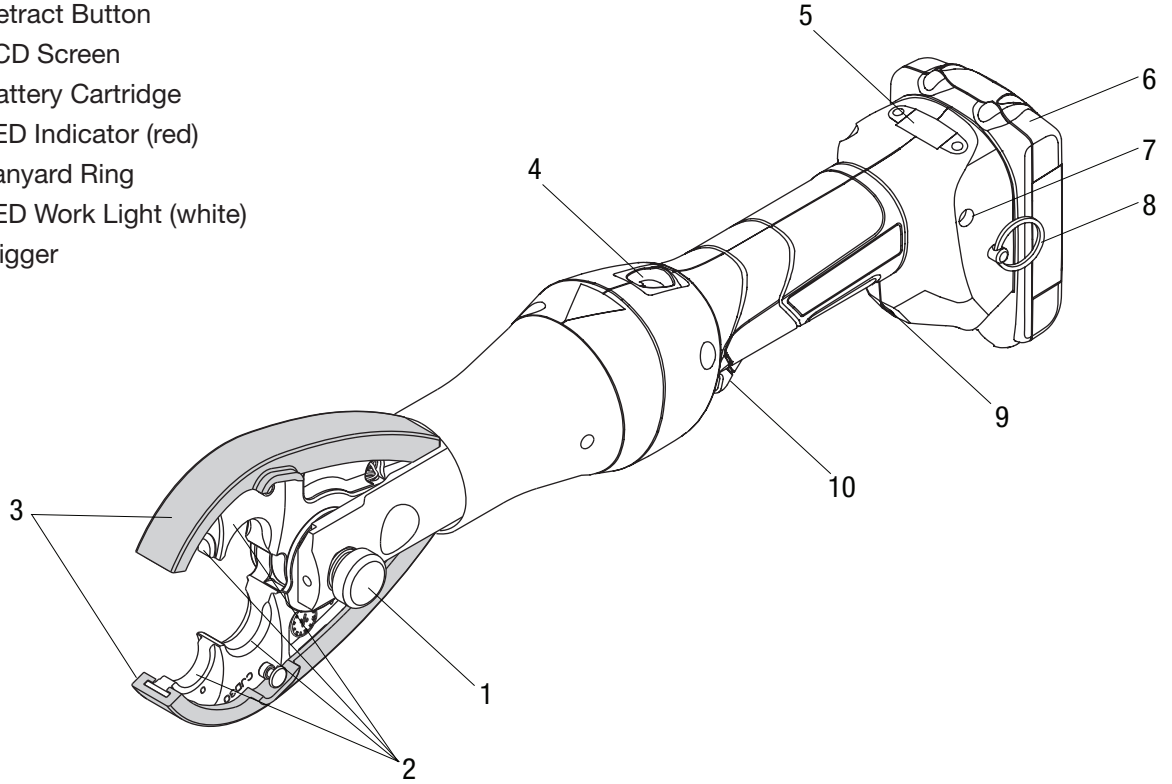

Specifications

Crimping Tool

Length.....	18" (456 mm)
Width	2.95" (75 mm)
Depth.....	4.92" (125 mm)
Weight.....	6.4 lb (2.9 kg)
Crimping Force.....	6 tons (53 kN)
Hydraulic Oil	Biodegradable hydraulic fluid
Recommended Operating Temperature Range.....	5 °F to 122 °F (-15 °C to 50°C)
Battery Charger.....	Read the instructions supplied with the battery charger

Operation
⚠ WARNING

- Inspect tool and dies before use. Replace any worn or damaged parts. A damaged or improperly assembled tool can break and strike nearby personnel.
- Carrying strap is for carrying only, not to be used to hang or suspend tool.

Failure to observe these warnings could result in severe injury or death.

⚠ WARNING

Electric shock hazard:

This tool is not insulated. When using this unit on or near energized electrical lines, use proper personal protective equipment.

Failure to observe this warning could result in severe injury or death.

⚠ WARNING

Wear eye protection when operating or servicing this tool.

Failure to wear eye protection could result in serious eye injury from flying debris or hydraulic oil.

⚠ WARNING

Pinch points:

- Remove battery before changing dies, adapters, or jaws.
- Keep hands away from the crimping tool head when crimping.

Failure to observe these warnings could result in severe injury or death.

⚠ CAUTION

- Do not use this tool for continuous use. After 30 to 40 cycles, allow the tool to cool for 15 minutes.
- Do not secure this tool in a vise. This tool is designed for hand-held operation.
- This tool may be used in damp or wet environments; however, air-drying is recommended before use if the tool becomes soaked. Damage may result when the tool is operated prior to thorough drying when electrical components are soaked.
- Use this tool for the manufacturer's intended purpose only.

Failure to observe these precautions may result in injury or property damage.

Charging the Battery

Read the instructions supplied with the battery charger.

LED Work Light (white)

This LED automatically turns on when the trigger is pulled. It remains on for 10 seconds after the trigger is released.

LED Indicator (red)

This tool is equipped with a special circuit board incorporating several important features to inform the user about the current status of the unit. The LED signals in the following cases:

What happens	Signal	What it means
Constant light for 20 seconds at end of cycle	█	Battery charge is below 17 V at beginning of cycle*
Tool will not start, and constant light for 20 seconds when trigger is released	█	Battery charge is below 16 V at beginning of cycle*
Tool will stop, and constant light for 20 seconds after trigger is released	█	Battery voltage drops below 13 V during cycle*
Tool will stop, and flashing light for 20 seconds when trigger is released	●●●●	Motor current exceeds 20 A during cycle
		Circuit has become too hot
Flashing light for 20 seconds at end of cycle	●●●●	Send tool in for service

* Running the battery below 16 V can damage the battery.

Operation (cont'd)

Pressure Sensor

This tool is equipped with a pressure sensor that alerts the user of an incomplete crimp.

- If the tool is manually retracted before completion of a crimp, the red LED and an audible beep will be active for 2 seconds.
- If the tool is unable to reach the required crimp force, the red LED, work light, and an audible beep will pulse until after the trigger is released.

Die Selection

Interchangeable dies may be used in the standard die opening. Dies that may be used include:

- Greenlee KD6 series
- Burndy W and X series
- ILSCO ND series
- Huskie HT58 series
- Panduit CD-2001 series
- Other industry W-type dies

Installing Dies

1. Select the proper dies for the connector to be crimped.
2. Install dies in jaws making certain that they are properly secured by the spring-loaded, positive lock, die buttons.

Preparing Cable

Follow the lug manufacturer's instructions for appropriate cable strip length.

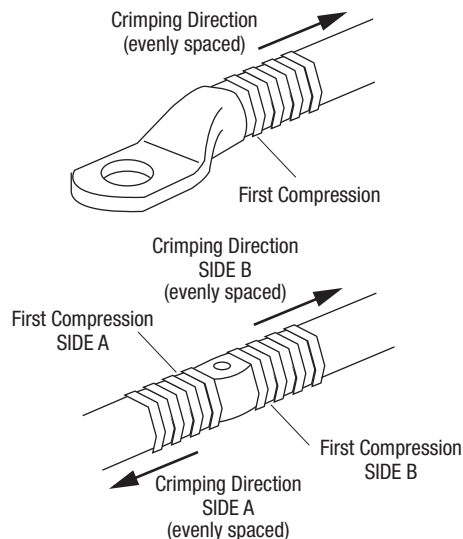

Crimping Procedure

1. Insert conductor into the connector and align the tool and die on the conductor. Start in the center for splices and "H" frames; and on the end, nearest the pad, for terminals.
2. Activate the tool by pulling the trigger. Continue to hold the trigger until the ram retracts. This is the signal that the crimp is complete.
3. Continue crimping the connector until the correct number of crimps has been completed. Work from the center to the outer edges for splices and "H" frame connectors, alternating sides if possible, for the best compression connections.

⚠ WARNING

An incomplete crimp can cause a fire.

- Use proper die, connector, and cable combinations. Improper combinations can result in an incomplete crimp.
- The relief valve sounds and the ram automatically retracts to indicate a completed crimp. If you do not hear the sound of the relieve valve or the ram does not automatically retract, the crimp is not complete.

Failure to observe these warnings could result in severe injury or death.

CJ22 Jaw and KA22/KC22-type Die Selection

Note: This tool will provide a cUL and UL classified crimp ONLY when used with the CJ22 jaws and KA22- or KC22-type dies.

Note: This tool will provide 53 kN (6 tons) of crimping force when used with the CJ22 jaws.

Crimps made on copper cable with Greenlee KC22-type dies and the copper connectors listed here are cUL and UL classified.

Crimps made on copper or aluminum cable with Greenlee KA22-type dies and the dual-rated aluminum connectors listed here are cUL and UL classified.

Refer to “Connector Selection” for brand names and model numbers of appropriate lugs as well as crimping instructions.

Dies for Copper Connectors

Catalog Number	UPC Number	Cable Size	Color Code
KC22-8	03079	8 AWG	Red
KC22-6	03080	6 AWG	Blue
KC22-4	03081	4 AWG	Gray
KC22-2	03082	2 AWG	Brown
KC22-1	03083	1 AWG	Green
KC22-1/0	03084	1/0 AWG	Pink
KC22-2/0	03085	2/0 AWG	Black
KC22-3/0	03086	3/0 AWG	Orange
KC22-4/0	03087	4/0 AWG	Purple
KC22-250	03088	250 kcmil	Yellow
KC22-300	03089	300 kcmil	White
KC22-350	03090	350 kcmil	Red
KC22-400	03091	400 kcmil	Blue
KC22-500	03092	500 kcmil	Brown
KC22-600B	03094	600 kcmil	Green

Dies for Dual-rated Aluminum Connectors

Catalog Number	UPC Number	Cable Size
KA22-8	06744	8 AWG
KA22-6	06745	6 AWG
KA22-4	06746	4 AWG
KA22-2	06747	2 AWG
KA22-1	06749	1 AWG
KA22-1/0	06750	1/0 AWG
KA22-2/0	06751	2/0 AWG
KA22-3/0	06752	3/0 AWG
KA22-4/0	06753	4/0 AWG
KA22-250	06754	250 kcmil
KA22-300	06755	300 kcmil
KA22-350	06756	350 kcmil

Connector Selection

CJ22 Crimping Jaw Range: Copper — 8 AWG to 600 kcmil†; Dual-rated Aluminum — 8 AWG to 350 kcmil

When used with KC22-type dies, this tool is cUL and UL classified for use with the following connector brands:

Connector Type	Barrel Type	Anderson	Blackburn®	Burndy	ILSCO	Panduit	T&B	Penn-Union†	No. of Crimps*
Copper Splice	Short	VHSS	CSP	YS-L▲	CT	SCSS/SCS	54504-54518	BCU	A
	Long	VHS	CU	YS▲	CTL	SCL/SCH	54804-54818	BBCU	
Copper Lugs	Short	VHCS	CTL-2/CTL	YA-2LN/YA-L/YA-2L YA/YA-L-TC/YA-L-2TC	CSW CRA/CRB	LCAS/LCA LCD	54104-54118 54204-54218	BLU	
	Long	VHCL	CTL-L/LCN	YA-2N	CLN/CLW CRA-L/CRB-L CRA-2L/CRB-2L	LCB/LCC	54930BE-54918BE 54850BE-54876BE	BBLU	

When used with KA22-type dies, this tool is cUL and UL classified for use with the following connector brands:

Connector Type	Barrel Type	Anderson	Blackburn®	Burndy	ILSCO	Panduit**	T&B	Penn-Union	No. of Crimps*
Dual-rated Aluminum Splice	—	VACS	ASP	YS-A	AS ASN	SA	60501-60565	PIK	B
Dual-rated Aluminum Lugs	—	VACL	ATL	YA-A YA-ATN	ACL/ACN 2ACL/2ACN ALNS/ALNN/ALND	LAA/LAB	60101-60166 60230-60267	BLUA	



* Use the number of crimps listed in the last column instead of the number provided with the connector:

A — 8 to 1/0 AWG: 1 crimp
2/0 AWG to 600 kcmil: 2 crimps

B — 8 to 2 AWG: 2 crimps
1 to 3/0 AWG: 3 crimps
4/0 AWG to 350 kcmil: 4 crimps

** 6 AWG to 350 kcmil

† 500 kcmil maximum with Penn-Union connectors

▲ 8 AWG to 350 kcmil with Burndy copper splices

LCD Screen

This tool has an LCD screen, which displays information about the tool. Turn on the screen by inserting the battery and jogging the tool. If there are any problems with the tool, an error code appears.

Error Code	Meaning
1	Overcurrent fuse
2	Overcurrent comparator
3	Overheated circuit board
4	Overheated battery
5	Battery empty; operation stops
6	Faulty crimp; complete cycle
7	Faulty crimp; incomplete cycle
8	Low battery
9	Battery empty; tool won't run
10	Real-time clock battery low
11	Tool deactivated
12	Service necessary
13	Real-time clock not found
14	Bluetooth® unit not found
15	
16	Pressure sensor not found
17	Burst pressure exceeded
18	Battery temperature too low

If there is no error code, cycle through the various displays using the left and right buttons on either side of the screen. There are seven displays in total.

Display	Information Shown
1	Bluetooth® status, battery charge, current pressure, max. pressure
2	Firmware, available firmware update, serial number
3	Current user. Press and hold both buttons to change user, select with right button, and confirm by jogging the tool.
4	
5	
6	Cycles until next service
7	Since manufacturing: operating hours, capacity, number of cycles

Maintenance

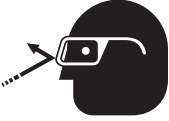
	⚠ WARNING
	<p>Wear eye protection when operating or servicing this tool.</p> <p>Failure to wear eye protection could result in serious eye injury from flying debris or hydraulic oil.</p>

	⚠ WARNING
	<p>Skin injection hazard:</p> <p>Do not use hands to check for oil leaks. Oil under pressure easily punctures skin. If injured, seek medical attention immediately to remove oil.</p> <p>Failure to observe this warning could result in serious injury, gangrene, or death.</p>

	⚠ WARNING
	<p>Do not use solvents or flammable liquids to clean the tool body. Solvents or flammable liquids could ignite and cause serious injury or property damage.</p>

	⚠ WARNING
	<p>Pinch points:</p> <ul style="list-style-type: none"> • Remove battery before changing dies, adapters, or jaws. • Keep hands away from the crimping tool head when crimping. <p>Failure to observe these warnings could result in severe injury or death.</p>

IMPORTANT
<p>Relief valve adjustments must be done by an authorized service center.</p>

Daily
Before use:

1. Inspect the tool for wear or damage, such as cracks, gouges, or chips.
2. Inspect the tool for damage or leaks.
3. Inspect the rotation of the head assembly. Fully retract the ram. The head should rotate no more than 360°. If damage is detected, contact Greenlee customer service at 800-435-0786 for warranty service or repair.

After use:

1. Use a damp cloth and mild detergent to clean the housing. Allow the housing to dry.
2. Fully retract the ram. Place the tool in the carrying case and store in a cool, dry place.
3. If necessary, recharge the batteries. Refer to the instructions supplied with the battery charger.

Monthly

Thoroughly clean all surfaces.

Annually or After 10,000 Crimps

Contact Greenlee customer service at 800-435-0786 for warranty service or repair, and hydraulic oil replacement.

Troubleshooting

Before You Begin

1. Make sure that the battery is charged. Recheck the battery after several minutes to make sure the battery is holding its charge.
2. Use a **nonflammable** contact cleaner or pencil eraser to clean the electrical contacts on the battery and tool.
3. Reinstall the battery and check the tool again.

Problem	Possible Cause	Probable Remedy
Tool is inoperative.	Dirt, contaminants, etc., in ram area of tool.	Clean tool.
	Tool components worn or damaged.	Contact Greenlee customer service at 800-435-0786 for warranty service or repair.
Motor is inoperative.	Low or uncharged battery.	Try known charged battery. Inoperative battery may be discharged or may have reached life expectancy.
	Broken switch components.	Contact Greenlee customer service at 800-435-0786 for warranty service or repair.
Motor runs but tool will not complete a cycle.	Oil level low.	Contact Greenlee customer service at 800-435-0786 for warranty service or repair.
	Air in hydraulic system.	Pull trigger and hold retract button simultaneously. Run for approximately 10 seconds, and then attempt to crimp. If unsuccessful, contact Greenlee customer service at 800-435-0786 for warranty service or repair.
	Cold oil.	Pull trigger and hold retract button simultaneously to warm oil. Store tool in warm area.
LED glows for 20 seconds.	Battery charge low.	Charge or replace battery.
Tool loses oil.	Damaged internal seal.	Contact Greenlee customer service at 800-435-0786 for warranty service or repair.



4455 Boeing Drive • Rockford, IL 61109-2988 • USA • 815-397-7070
An ISO 9001 Company • Greenlee Textron Inc. is a subsidiary of Textron Inc.

www.greenlee.com

USA Tel: 800-435-0786
Fax: 800-451-2632

Canada Tel: 800-435-0786
Fax: 800-524-2853

International Tel: +1-815-397-7070
Fax: +1-815-397-9247