

INSTRUCTION MANUAL

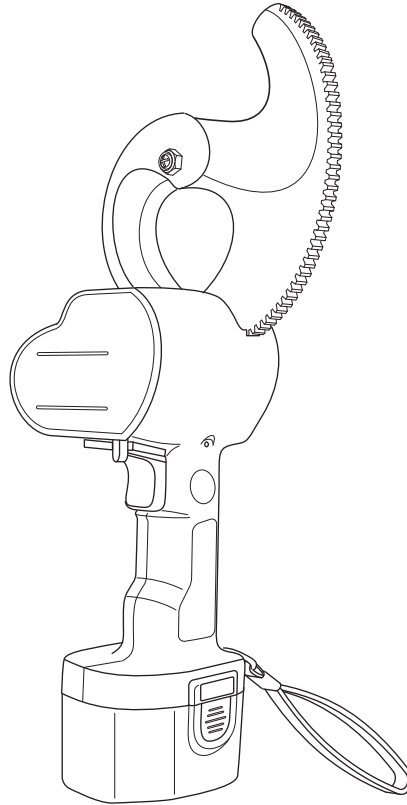

GREENLEE®

A Textron Company



ES25

Battery-powered ACSR Cutter

22131 – with 120V Charger

22132 – with 220V Charger



Read and understand all of the instructions and safety information in this manual before operating or servicing this tool.

Table of Contents

Description	2
Safety	2
Purpose of this Manual	2
Important Safety Information	3-5
Identification	6
Specifications	6
Operation	7
Maintenance	8
Troubleshooting	9
Illustration and Parts List	10-11

Description

The Greenlee ES25 Battery-powered Cutter is intended to cut up to 636 kcmil Grosbeak ACSR cable.

The cable cutter is driven by a 14.4 V motor and is powered by a rechargeable NiCd (nickel cadmium) battery. The motor is protected by a circuit breaker.

Safety

Safety is essential in the use and maintenance of Greenlee tools and equipment. This instruction manual and any markings on the tool provide information for avoiding hazards and unsafe practices related to the use of this tool. Observe all of the safety information provided.

Purpose of this Manual

This manual is intended to familiarize all personnel with the safe operation and maintenance procedures for the following Greenlee tools:

ES25-11 Battery-powered ACSR Cutter, 120 V

ES25-22 Battery-powered ACSR Cutter, 220 V

Keep this manual available to all personnel.

Replacement manuals are available upon request at no charge at www.greenlee.com.



Do not discard this product or throw away!

For recycling information, go to www.greenlee.com.

All specifications are nominal and may change as design improvements occur. Greenlee Textron Inc. shall not be liable for damages resulting from misapplication or misuse of its products.

KEEP THIS MANUAL

IMPORTANT SAFETY INFORMATION

Cable Cutter

	<h2 style="margin: 0;">SAFETY ALERT SYMBOL</h2>
<p>This symbol is used to call your attention to hazards or unsafe practices which could result in an injury or property damage. The signal word, defined below, indicates the severity of the hazard. The message after the signal word provides information for preventing or avoiding the hazard.</p>	
<h3 style="margin: 0;">⚠ DANGER</h3>	
<p>Immediate hazards which, if not avoided, WILL result in severe injury or death.</p>	
<h3 style="margin: 0;">⚠ WARNING</h3>	
<p>Hazards which, if not avoided, COULD result in severe injury or death.</p>	
<h3 style="margin: 0;">⚠ CAUTION</h3>	
<p>Hazards or unsafe practices which, if not avoided, MAY result in injury or property damage.</p>	

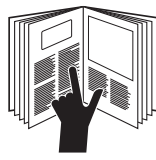
	<h3 style="margin: 0;">⚠ WARNING</h3>
<p>Read and understand all of the instructions and safety information in this manual before operating or servicing this tool.</p>	
<p>Failure to observe this warning could result in severe injury or death.</p>	

Note: Keep all decals clean and legible, and replace when necessary.

	<h3 style="margin: 0;">⚠ WARNING</h3>
<p>Electric shock hazard: This tool is not insulated. When using this unit near energized electrical lines, use proper personal protective equipment.</p>	
<p>Failure to observe this warning could result in severe injury or death.</p>	

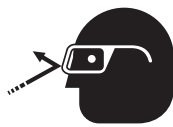
	<h3 style="margin: 0;">⚠ WARNING</h3>
<p>Wear eye protection when operating or servicing this tool.</p>	
<p>Failure to wear eye protection could result in serious eye injury from flying debris.</p>	

	<h3 style="margin: 0;">⚠ WARNING</h3>
<ul style="list-style-type: none"> Keeps hands away from blade. Remove the battery before inspecting or servicing the tool. 	
<p>Failure to observe these warnings could result in severe injury or death.</p>	

<h3 style="margin: 0;">⚠ CAUTION</h3>
<ul style="list-style-type: none"> Use this tool for manufacturer's intended use only. Use other than that which is described in this manual can result in injury or property damage. Do not cut guy wire or steel rod. Do not exceed the rated capacity of the tool. Inspect the tool before each use. Replace any worn, damaged, or missing items with Greenlee replacement parts. A damaged or improperly assembled tool can break and strike nearby personnel.
<p>Failure to observe these precautions may result in injury or property damage.</p>

IMPORTANT SAFETY INFORMATION

Battery

⚠ WARNING

Do not dispose of battery in a fire. The battery will vent harmful vapors and can explode.

Failure to observe this warning could result in severe injury or death.

⚠ CAUTION

Do not allow any object to contact the battery terminals.

- Do not immerse batteries in liquid. Liquid may create a short circuit and damage the battery.
- Do not place the battery into a pocket, tool pouch, or tool box with conductive objects. Conductive objects may create a short circuit and damage the battery.
- Do not place a battery on moist ground or grass. Moisture may create a short circuit and damage the battery.

Failure to observe these precautions may result in injury or property damage.

⚠ CAUTION

- Do not charge the battery if it is cooler than 50 °F (10 °C) or warmer than 95 °F (35 °C). Damage to the battery can result.
- Do not store the battery at more than 140 °F (60 °C). Damage to the battery can result.
- Do not use another manufacturer's charger. Other manufacturers' chargers may overcharge and damage the battery.

Failure to observe these precautions may result in injury or property damage.

⚠ CAUTION

- Do not expose the battery to liquids such as water, oil, or solvents. Liquids will damage the battery.
- Do not attempt to open the battery. It contains no user-serviceable parts.
- Use this battery for manufacturer's intended use only. Use other than that which is described in this manual can result in injury or property damage.
- Inspect the battery before each use. Do not use a damaged battery.

Failure to observe these precautions may result in injury or property damage.

IMPORTANT SAFETY INFORMATION

Charger

	⚠ WARNING
	<p>Electric shock hazard:</p> <ul style="list-style-type: none">• Use indoors only.• Do not expose the charger to rain, snow, or wet conditions.• Unplug the charger from the power source before cleaning the charger. <p>Failure to observe these warnings could result in severe injury or death.</p>

⚠ WARNING
<p>Greenlee recommends plugging the charger directly into a receptacle. If an extension cord must be used:</p> <ul style="list-style-type: none">• Select an extension cord with a configuration that exactly matches that of the charger's plug.• Inspect the extension cord for wear or damage. <p>Use of an improper or damaged extension cord could result in electric shock or fire.</p>

⚠ WARNING
<ul style="list-style-type: none">• Do not obstruct the ventilation slots. This device generates heat while charging. Excessive internal heat can result in a fire.• Do not use or store the charger near a heat source. This device generates heat while charging. Excessive internal heat can result in a fire. <p>Failure to observe these warnings could result in severe injury or death.</p>

⚠ WARNING
<p>Use this charger to charge the supplied 14.4 V rechargeable NiCd (nickel cadmium) batteries only. Other batteries may burst if charged with this charger. Failure to observe this warning could result in severe injury or death.</p>

⚠ CAUTION
<p>Do not place anything other than the supplied 14.4 V rechargeable NiCd (nickel cadmium) battery into the battery pocket.</p> <ul style="list-style-type: none">• Keep dirt and foreign objects out of the battery pocket.• Do not create a short circuit across the contacts in the battery pocket. <p>Failure to observe this precaution may result in injury or property damage.</p>

⚠ CAUTION
<ul style="list-style-type: none">• Do not connect the charger to a generator. Voltage fluctuations can damage the charger.• Inspect the charger before each use. Replace the unit if either the charger or cord show signs of damage or wear.• Do not attempt to repair the charger. It contains no user-serviceable parts.• Use this tool for manufacturer's intended use only. Use other than that which is described in this manual can result in injury or property damage. <p>Failure to observe these precautions may result in injury or property damage.</p>

Identification

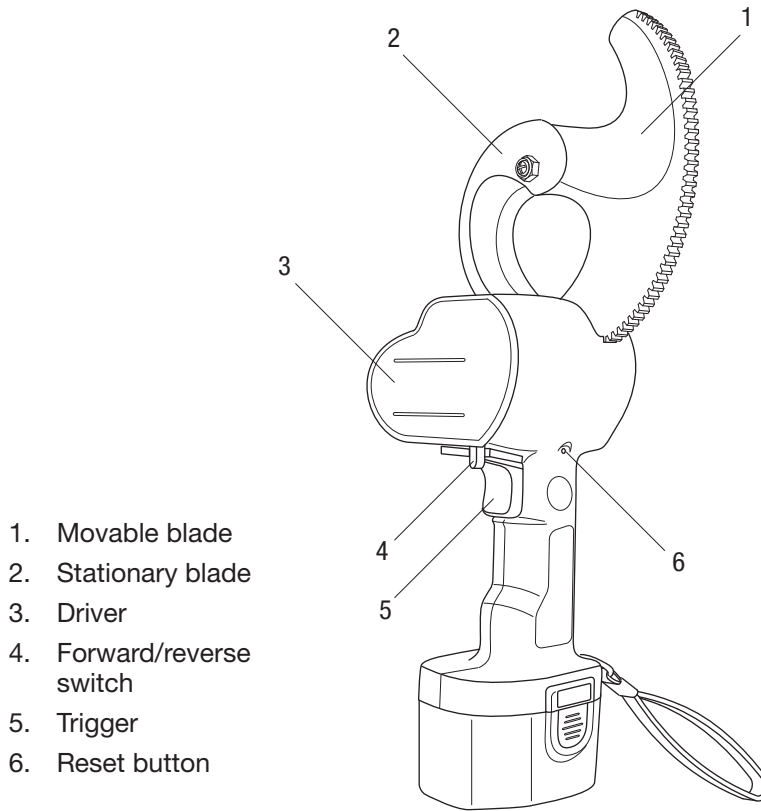

Specifications

Cable Cutter

Weight (with battery)3.5 kg (7.7 lb)

Motor..... 14.4 VDC

Capacity

ACSR636 kcmil (except Egret)

Aluminum..... 1500 kcmil

Battery

Type.....Rechargeable nickel-cadmium

Voltage 14.4 V

Charger

Voltage 120 VAC or 220 VAC

Operation

	⚠ WARNING
	<p>Electric shock hazard:</p> <p>This tool is not insulated. When using this unit near energized electrical lines, use proper personal protective equipment.</p> <p>Failure to observe this warning could result in severe injury or death.</p>

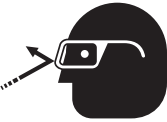
	⚠ WARNING
	<p>Wear eye protection when operating or servicing this tool.</p> <p>Failure to wear eye protection could result in serious eye injury from flying debris.</p>

⚠ CAUTION
<p>Do not cut steel.</p> <p>Failure to observe this precaution may result in injury or property damage.</p>

1. Activate the switch to open the movable blade.
2. Place the cable to be cut onto the stationary blade and close the movable blade around the cable. Feed the movable blade by hand so that the gear teeth engage the drive mechanism of the tool.
3. Slide the direction control lever to FORWARD. Press and hold the trigger switch until the cable is completely cut.
4. Slide the direction control lever to the center (LOCK) position.
5. When finished, remove any dust or particles that may have become attached to the brush.

Circuit Breaker

The following may cause the circuit breaker to trip:

- Cutting material that is too large
- Cutting material that is too hard
- Overheating due to continuous use
- Drawing excessive current

If the circuit breaker trips, the tool will stop. If necessary, allow the tool to cool down. Press the RESET button. (Wait 10 seconds to one minute before resetting.)

Removing the Battery

⚠ WARNING
<p>Do not dispose of battery in a fire. The battery will vent harmful vapors and can explode.</p> <p>Failure to observe this warning could result in severe injury or death.</p>

1. Press the battery latch on the battery.
2. Pull the battery down and out of the tool.

Charging the Battery

⚠ CAUTION
<p>Do not connect the charger to a generator. Voltage fluctuations can damage the charger.</p> <p>Failure to observe this precaution may result in injury or property damage.</p>

The battery charger will recharge the battery in approximately one hour.

1. Set the charger on a firm level surface out of direct sunlight. Be sure that the charger's ventilation slots are not blocked.
2. Connect the charger to an appropriate power supply.
3. Insert the battery into the battery pocket of the charger. The red LED will light to indicate that the battery is charging. The red LED turns off and the green LED turns on when the battery is at 80% capacity. To reach 100% capacity will take approximately 13 to 15 hours after the green LED switches on.

Note: It is acceptable to use the battery after the red LED turns off and the green LED turns on.

4. Remove the battery from the charger.

Note: Allow the charger to cool for at least 15 minutes before charging another battery.

Maintenance

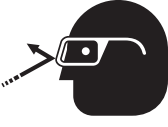
	⚠ WARNING
	<p>Wear eye protection when operating or servicing this tool.</p> <p>Failure to wear eye protection could result in serious eye injury from flying debris.</p>

	⚠ WARNING
	<ul style="list-style-type: none"> • Keeps hands away from blade. • Remove the battery before inspecting or servicing the tool. <p>Failure to observe these warnings could result in severe injury or death.</p>

Daily Maintenance

- Store the tool in a cool, dry area to prevent rust.
- Inspect the blades for damage or burrs. Remove burrs on the back side of the blades with a flat grinding stone.
- Clean the plastic housing with a soft, soaped cloth.

Replacing the Gear Guides

1. This tool has two gear guides — left and right. Operate the cutter in either the forward or reverse direction to move the blade completely out of the gear mechanism.
2. Remove the battery from the cutter.
3. Use an M2.5 Allen wrench to loosen and remove the screw that secures the gear guide and install the replacement guides on the movable blade.
4. Tighten the screw securely.
5. Re-install the battery and operate the cutter.

Replacing the Movable Blade

1. Operate the cutter in either the forward or reverse direction until the movable blade is clear of the pinion gear.
2. Remove the battery from the cutter.
3. Secure the lock nut with a wrench, and then loosen the shoulder screw with a screwdriver.
4. Remove the movable blade from the tool. Be sure not to lose the two curved washers.
5. Use an M2.5 Allen wrench to loosen and remove the two screws that secure the left and right orange gear guides to the movable blade.
6. Install the left and right gear guides on the new movable blade. Put the right gear guide on the right side of the blade and the left gear guide on the left side of the blade and tighten securely. A lock washer is located between the screw head and the gear guide.
7. Install the new movable blade by reassembling the shoulder screw and lock nut.
8. Re-install the battery and operate the cutter.

Troubleshooting

Problem	Probable Cause	Probable Remedy
Cutter does not operate.	Battery is discharged.	Charge battery.
	Internal circuit breaker has tripped.	Reset circuit breaker.
	Movable blade is not completely engaged.	Push movable blade until it is completely engaged with drive.
	Dust or foreign matter lodged at battery contacts.	Clean battery contacts.
Charging LED does not illuminate.	Battery contacts are dirty.	Clean battery contacts on battery and in battery charger.
	Battery cartridge is too warm.	Allow battery to cool.
Battery life has decreased.	Battery will not hold a charge.	Replace battery.
	Blades are dull.	Replace blades.

Illustration

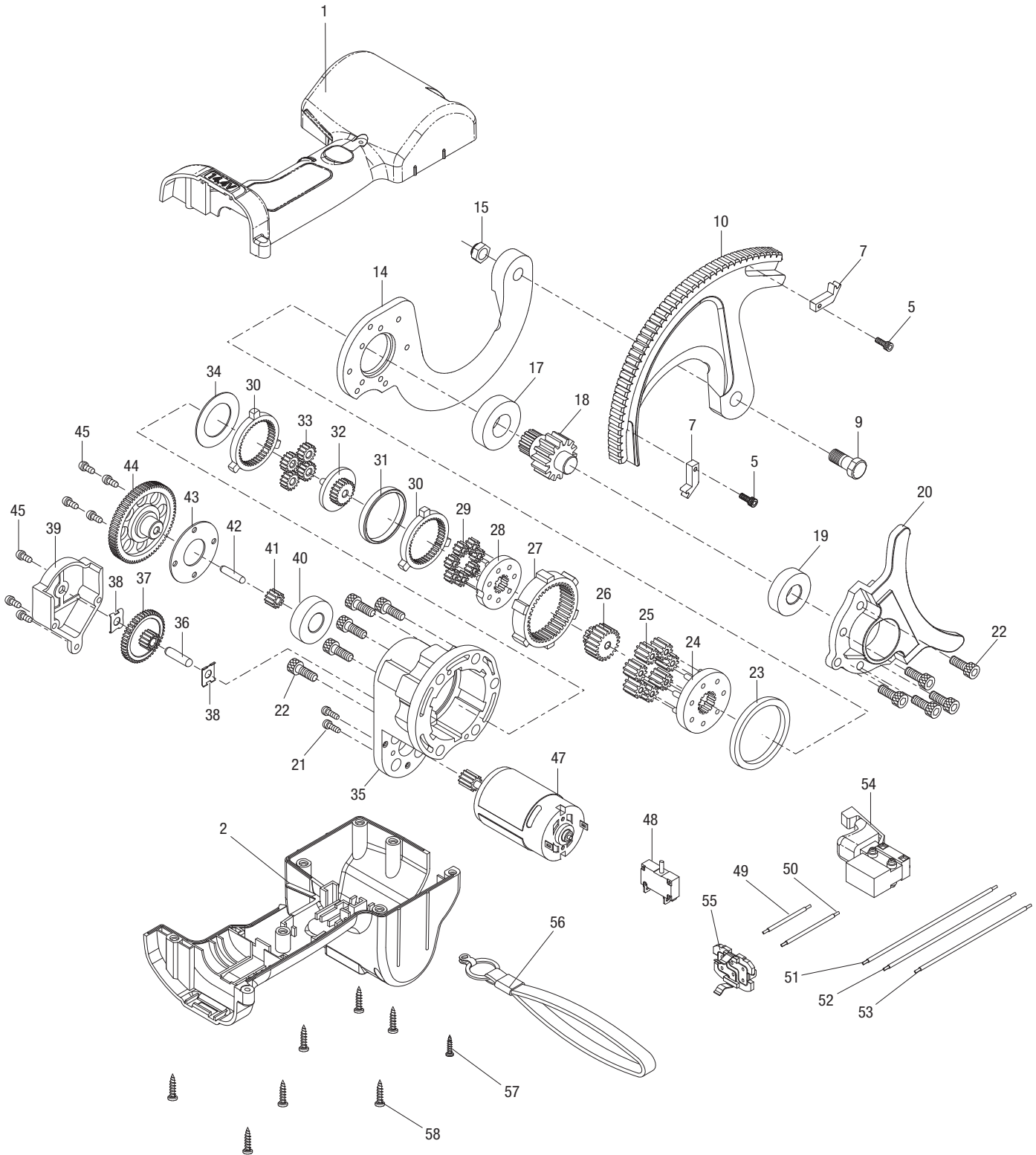

Parts List

Key	Part No.	Description	Qty
1*		Left housing	1
2*		Right housing	1
5†	52078339	Screw, M3 x 3	2
7†	52078340	Gear guides set.....	1
9†	52022508	Shoulder screw, M10 x 1.5	1
10†	52022511	Movable blade	1
14†	52022507	Stationary blade.....	1
15†	52022509	Nut, M10 x 1.5	1
17-45	52022504	Planetary gearbox	1
47	52022510	Motor with gear.....	1
48	50119958	Circuit breaker.....	1
49-53		Wires	1 ea.
54	50119940	Switch	1
55	50119974	Contact	2
56	50119931	Wrist strap.....	1
57*		Screw, M3 x 15	1
58*		Screw, M4 x 18	7
Decals			
*	52022137	Identification decal.....	2
*	52022136	Warning decal	1
	50118471	Battery decal.....	1
Kits			
	52022505	Housing kit (includes items marked with an asterisk)	
	52022506	Blade kit (includes items marked with †)	
	52033799	Drive gear and bearing kit (includes items 18-20)	
	50118510	14.4 V battery	
	50118412	120 V charger	
	50118560	220 V charger	
	50118455	Plastic case	
	50051920	Case decal	
	52020084	Plastic case clip (service item only)	



4455 Boeing Drive • Rockford, IL 61109-2988 • USA • 815-397-7070
An ISO 9001 Company • Greenlee Textron Inc. is a subsidiary of Textron Inc.
www.greenlee.com

USA Tel: 800-435-0786
Fax: 800-451-2632

Canada Tel: 800-435-0786
Fax: 800-524-2853

International Tel: +1-815-397-7070
Fax: +1-815-397-9247